

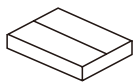

10 min



x1



x1

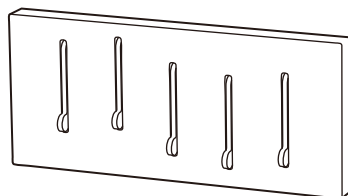
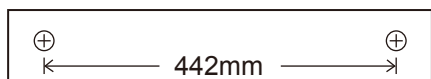

**(A)** x 1

**(B)** x 1



**(C)** x 2 (Ø6x30.5mm)

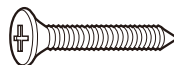

**(D)** x 2 (Ø4x32mm)

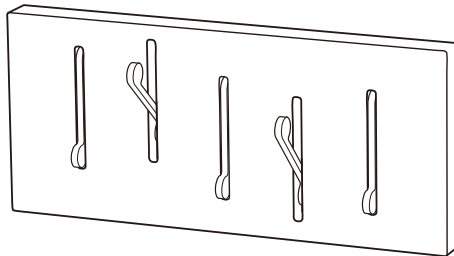
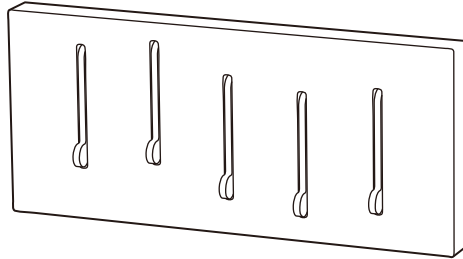



1

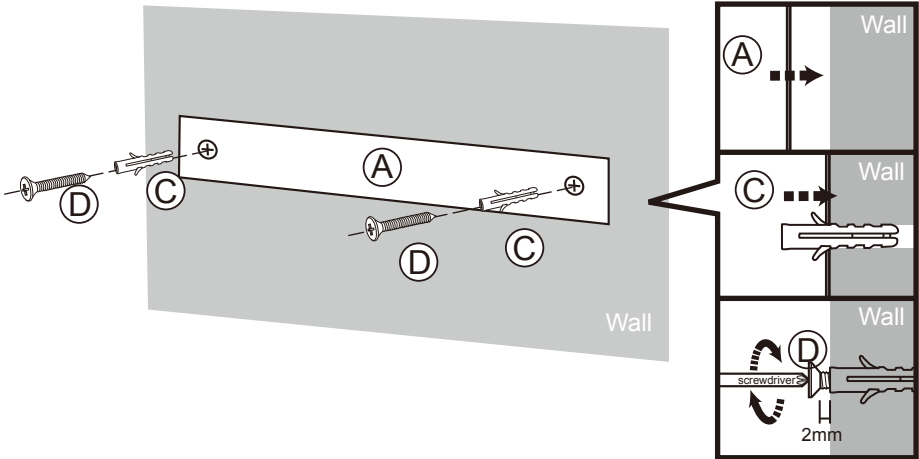



2

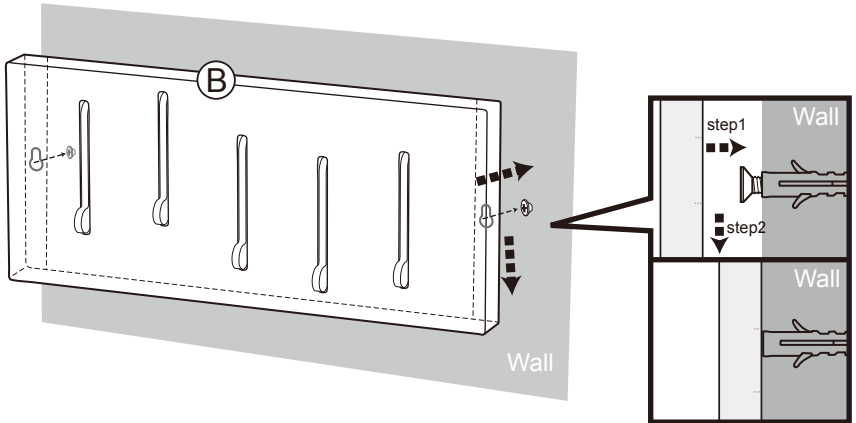

**THAT'S ALL FOLKS!**

**JULIÀ GRUP Furniture Solutions S.L.**

B-17616277

Pol. Ind. Bosc d'en Cuca

C / Tallers, 14

17410 Sils SPAIN

[contact@kavehome.com](mailto:contact@kavehome.com)