

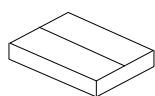

30 min

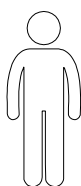

x1



x1

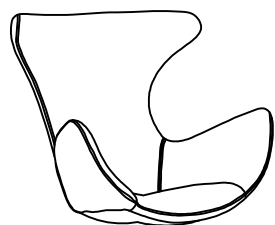

D=1PC



E=1PC



M5

A=1PC



M8\*25

B=4PCS



C=4PCS

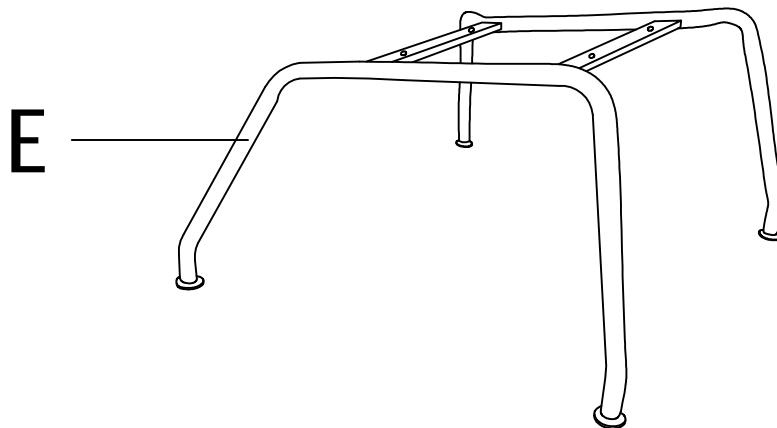
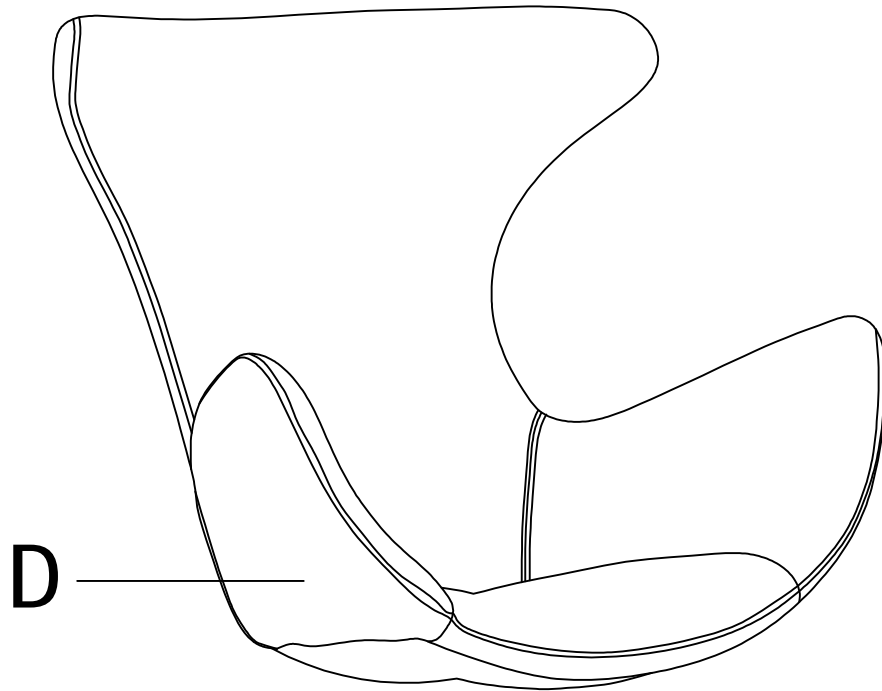



①

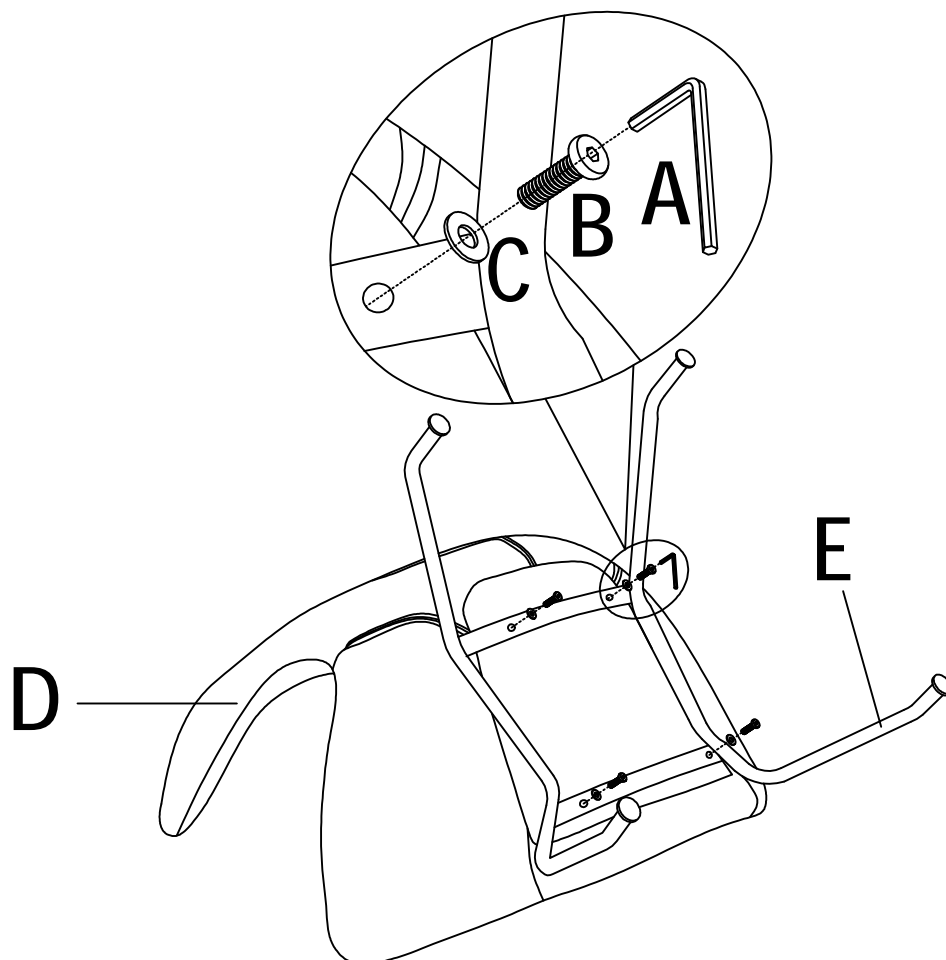

②

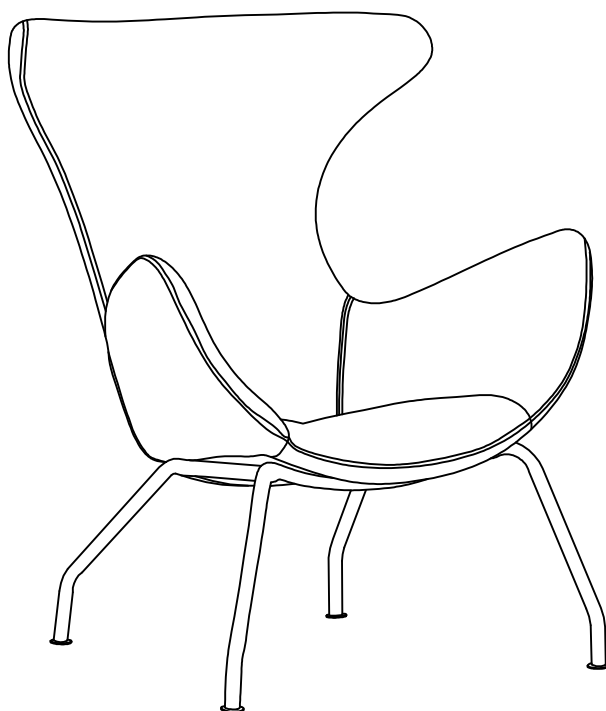





**JULIÀ GRUP Furniture Solutions S.L.**

B-17616277

Pol. Ind. Bosc d'en Cuca

C / Tallers, 14

17410 Sils SPAIN

[contact@kavehome.com](mailto:contact@kavehome.com)