

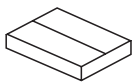

45 min



x1



x2

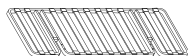

1 x1

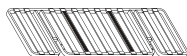

2 x1



3 x1

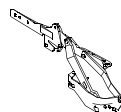

4 x1

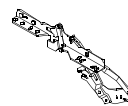

5 x1



6 x1

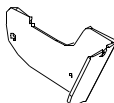

7 x1

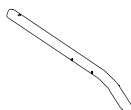

8 x1

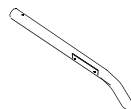

9 x1



10 x1

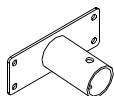

11 x2



12 x2

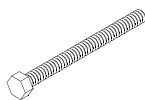

A x2

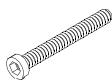

B x2



C x2



D x8



E x8



F x12



G x1

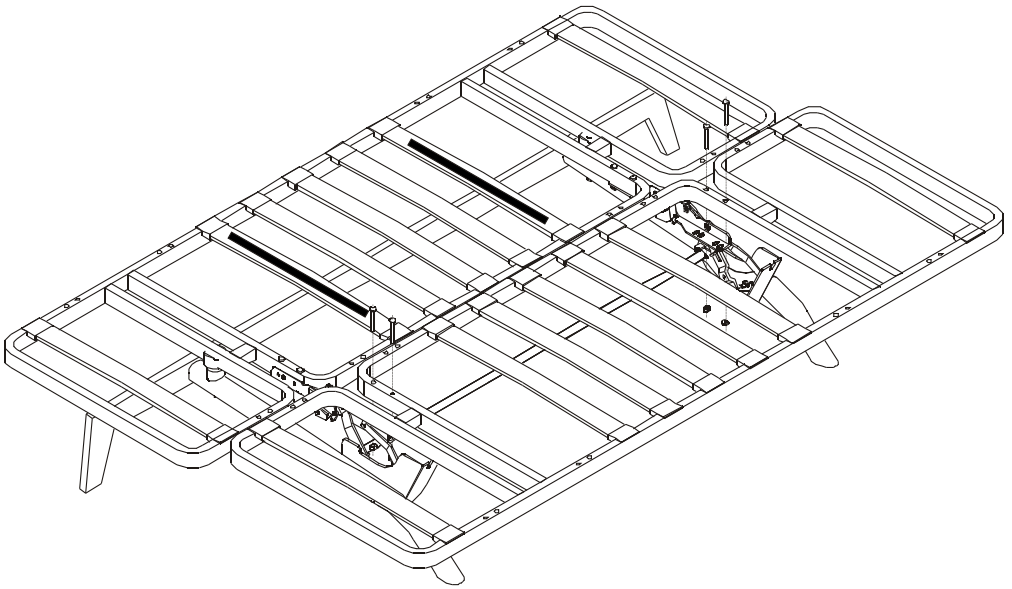



1

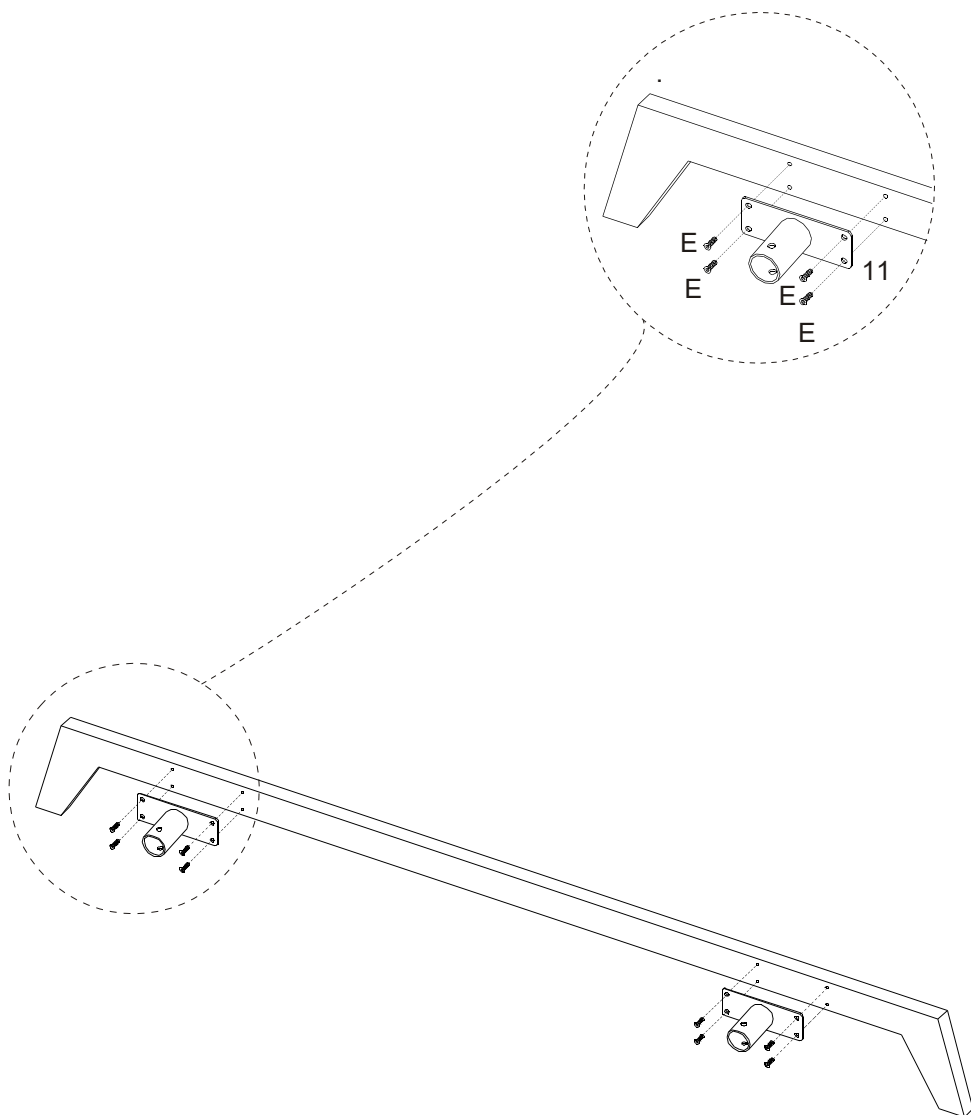



2

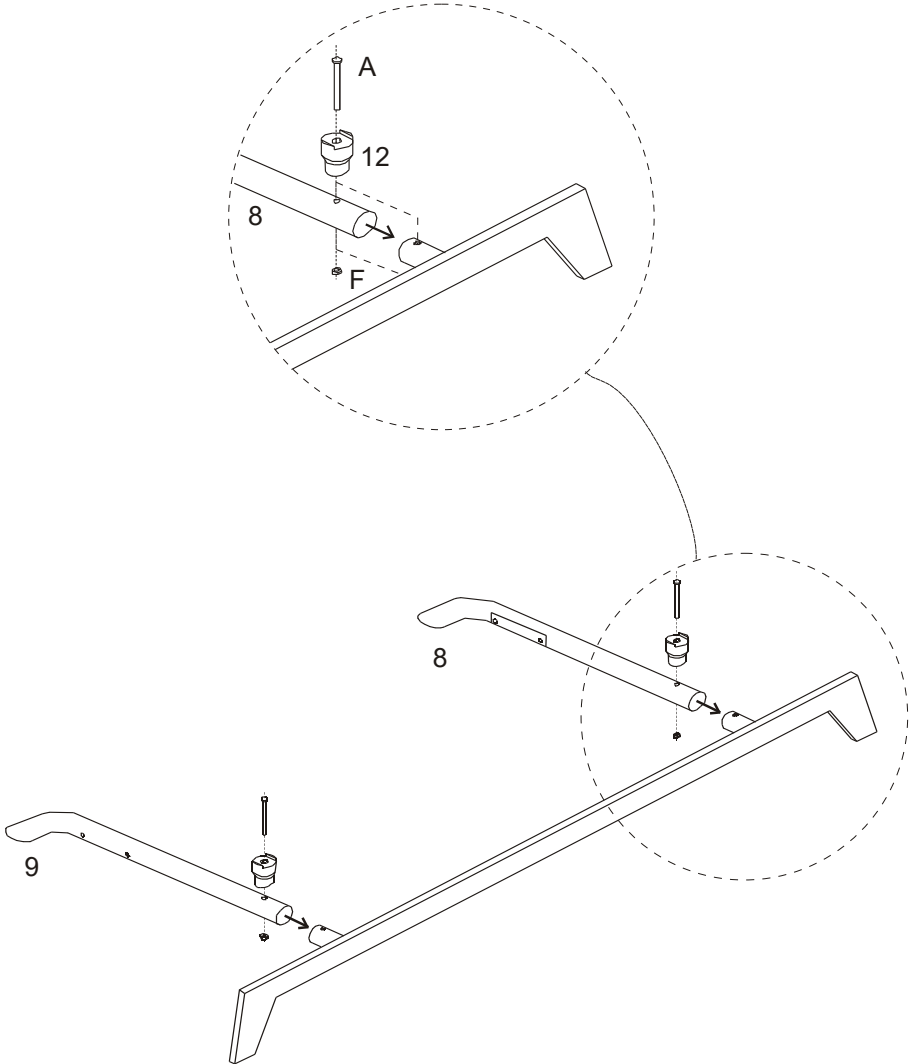



3

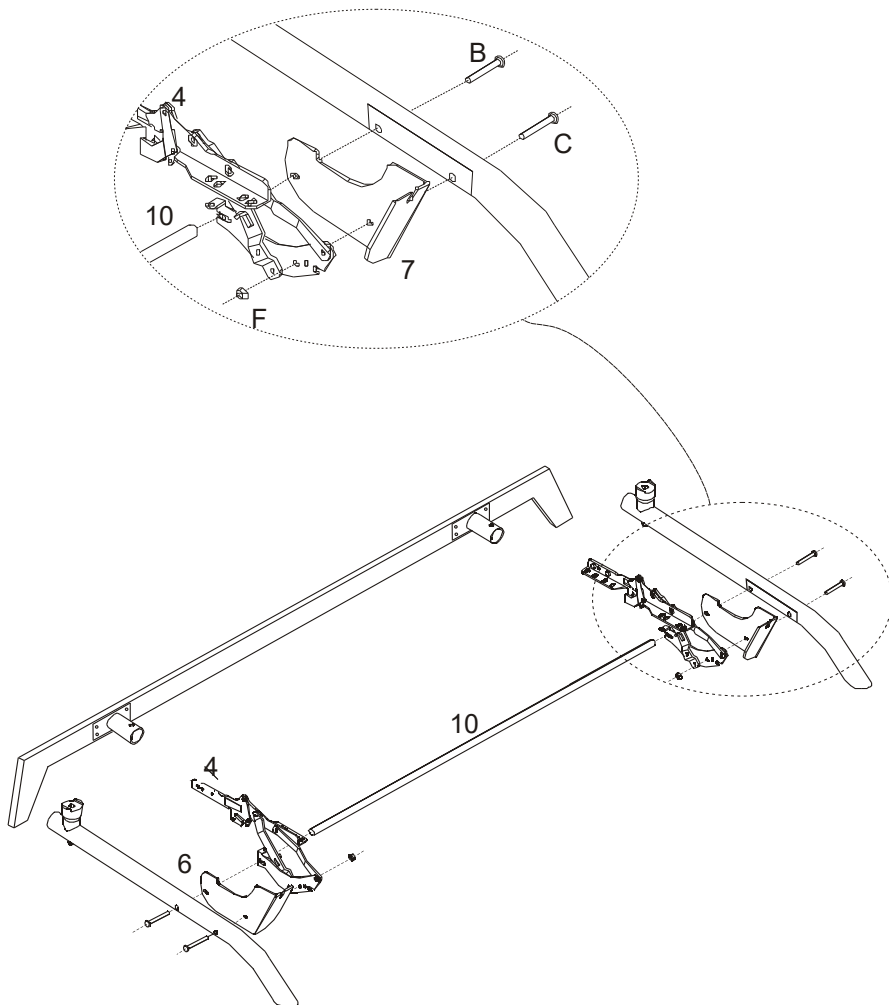



4

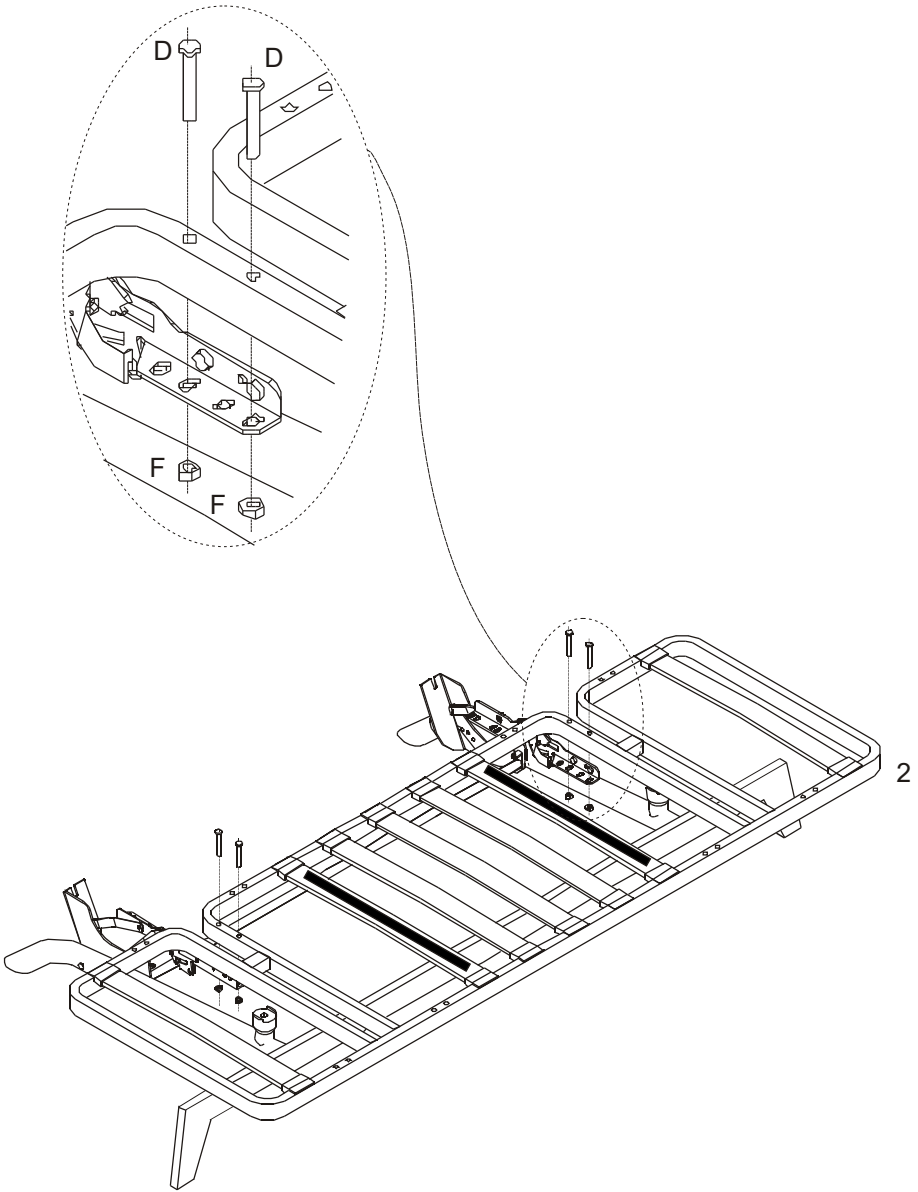





5

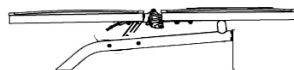
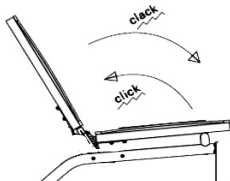
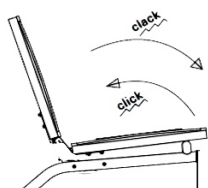
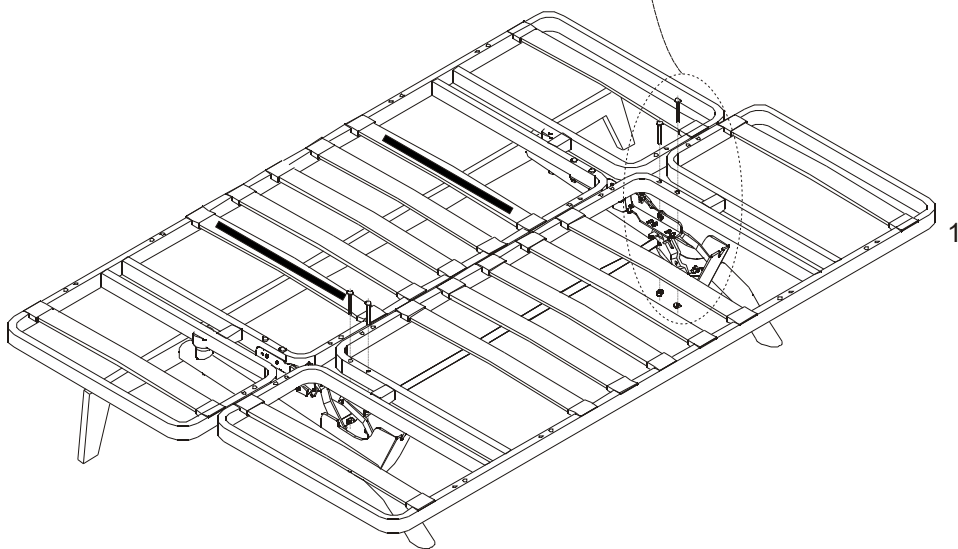
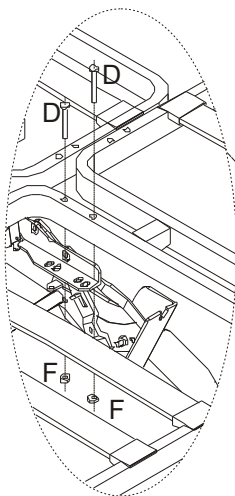

S595





**JULIÀ GRUP Furniture Solutions S.L.**

B-17616277

Pol. Ind. Bosc d'en Cuca

C / Tallers, 14

17410 Sils SPAIN

[contact@kavehome.com](mailto:contact@kavehome.com)